

# PORTFOLIO

---

OPTIONS ET ACCESSOIRES DU CATALYST 5 VX



## CATALYST 5 VX

### Assise

Croissillons standards  
[5VXBR001]



Fixation pour plaque d'assise  
[5VXBR003]



Plaque d'assise rigide en  
aluminium [5VACC004]



### Type de dossier

Réglable en angle avec  
poignées réglables en  
hauteur [5VBOP004]



Dossier pliant mi-  
hauteur [5VBOP029]



Fixe avec poignées de  
poussée [5VBCK004]



Fixe sans poignées de  
poussée [5VBCK008]



Fixe avec courbure  
lombaire de 8°, avec  
poignées [5VBOP003]



Fixe avec poignées de  
poussée rabattables  
[5VBCK006]

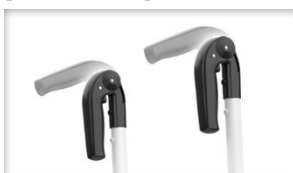

Dossier à hauteur  
réglable pour l'aidant  
[5VBOP034]



### Rembourrage du dossier et poignées de poussée

Rembourrage standard  
[5VBUP001]

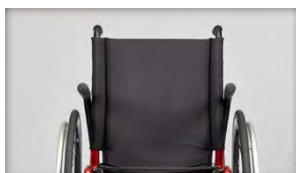

Réglable en tension,  
toile en nylon  
[5VBUP002]



Réglable en tension,  
toile en maille respirante  
[5VBUP007]



Poignées de poussée  
courtes [5VBCK007]

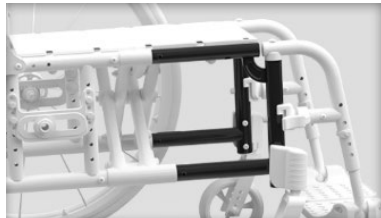
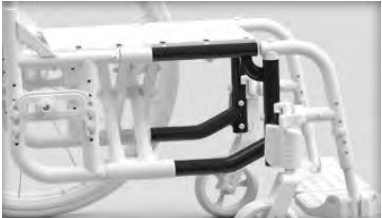
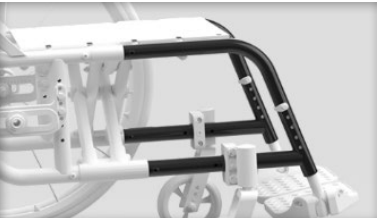

## Type de châssis

<p>Potences escamotables, cadre avant droit [5VFRM001]</p> 	<p>Potences escamotables, cadre avant Design [5VFRM002]</p> 	<p>Potences fixes [5VFRM003] [5VFRM004]</p> 
--	---	---





## Support de cadre avant / Repose-pieds

<p>Montage standard [5VHAN001] [5VHAN002] [5VHAN003]</p> 	<p>Montage haut [5VHAN016] [5VHAN017] [5VHAN004]</p> 	<p>Repose-jambe inclinable (PRO ELR) [50HAN044]</p> 	<p>Palette en composite [5VFPL001]</p> 
<p>Composite, réglable en angle [5VFPL014]</p> 	<p>Aluminium, réglable en angle [5VFPL002]</p> 	<p>Monobloc relevable [5VFPL009]</p> 	<p>Sangle talonnière standard [5VACC008]</p> 
<p>Verrou de potence classique [5VREL001]</p> 	<p>4 positions – en ligne [5VREL002]</p> 	<p>4 positions – extérieur [5VREL003]</p> 	<p>Sangle appui-mollet fermeture velcro, réglable [5VACC002]</p> 
<p>Sangle appui-mollet rembourrée fermeture velcro, réglable [5VACC003]</p> 	<p>Protection en gel PRO ELR (paire) [5VELRPAD]</p>	<p>Repose jambe [5VRLS001] [5VRLS002]</p> 	



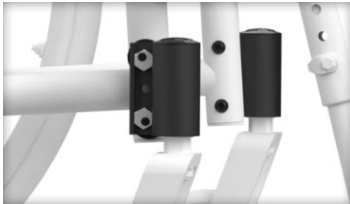



## Roues avant

<p>Roue type roller 0.75" [5VCAS004]]</p> 	<p>Roue type roller lumineuse 0.75" [5VCAS005]</p> 	<p>1" Poly [5VCAS006] [5VCAS010] [5VCAS014] [5VCAS019] [5VCAS020]</p> 
<p>1" Poly aluminium [5VCAS007] [5VCAS011]</p> 	<p>1" pneu [5VCAS017] [5VCAS021]</p> 	<p>1.5" Poly [5VCAS032] [5VCAS025] [5VCAS026]</p> 
<p>1.5" Aluminium souple [5VCAS009] [5VCAS013] [5VCAS016]</p> 	<p>2" Poly [5VCAS024]</p> 	<p>2" Pneu avec insert en mousse [5VCAS023]</p> 

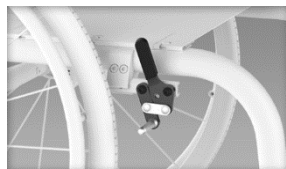

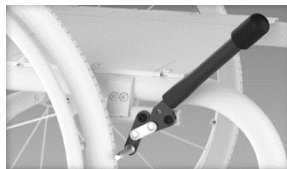

## Fourches et supports de fourches

<p>Tube de fourche standard [5VCST001]</p> 	<p>Fourche Standard [5VCSH001]</p> 	<p>Fourche Performance [5VCSH002]</p> 
<p>Frog Legs Suspension [50CST013]</p> 	<p>Frog Legs II Suspension [50CST014]</p> 	

## Freins

<p>Freins à pousser, levier droit [5VWLK002]</p> 	<p>Freins à pousser, levier courbé [5VWLK001]</p> 	<p>Freins à tirer [5VWLK003]</p> 	<p>Freins compacts (pince) [5VWLK012]</p> 
<p>Freins à tambour [5VWLK015]</p> 	<p>Rallonge de levier [5VWLK004]</p> 	<p>Système anti-recul [5VWLK009]</p> 	

## Roues arrière



<p>Maxx 18 rayons [5VWH1124] [5VWH1120] [5VWH1122] [5VWH1125] [5VWH1126]</p> 	<p>Maxx Mag [5VWHE120] [5VWHE122] [5VWHE124]</p> 	<p>Superlight 32 rayons [5VWHE224] [5VWHE225]</p> 	<p>Spinergy 18 rayons [5VWHE422] [5VWHE424] [5VWHE425] [5VWHE426]</p> 
--	--	--	---

## Pneus

<p>Pneu large à crampons 1 3/8" [5VTIR001]</p> 	<p>Bandage large 1 3/8" [5VTIR002]</p> 	<p>Pneu avec insert Air Less 1 3/8 [5VTIR004]</p> 
<p>Schwalbe HS-127 1 3/8 [5VTIR017]</p> 	<p>Bandage fin 1" [5VTIR003]</p> 	<p>Pneu plein Sentinel 1" [5VTIR005]</p> 

<p>Pneu haute pression 1" [5VTIR006]</p> 	<p>Schwalbe Marathon plus évolution 1" [5VTIR010]</p> 	<p>Pneu plein Shox [5VTIR019]</p> 
--	---	---







## Mains courantes

<p>Aluminium anodisé [5VHRM001]</p> 	<p>Aluminium ultraléger anodisé [5VHRM010]</p> 	<p>Revêtement anti-dérapant [5VHRM002]</p> 	<p>Main-courante plot de propulsion [5VHRM003]</p> 
<p>Natural Fit LT regular Grip [5VHRM005]</p> 	<p>Natural Fit Standard Regular Grip [5VHRM008]</p> 	<p>Natural Fit LT super Grip [5VHRM006]</p> 	<p>Natural Fit Standard Super Grip [5VHRM009]</p> 
<p>Natural Fit LT sans revêtement [5VHRM004]</p> 	<p>Natural Fit Standard sans revêtement [5VHRM007]</p> 	<p>Rouleau 3M micro-grip [5VACC006]</p> 	<p>Montage main-courante étroit [5VTAB001]</p> 





## Axes et carrossage des roues arrière

<p>Axe démontage rapide [50AXO003]</p> 	<p>Tétra-clips [50AXO001]</p> 	<p>Carrossage [5VWC00] [5VWC10] [5VWC02] [5VWC11] [5VWC04] [5VWC12] [5VWC13] [5VWC14] [5VWC15]</p> 
--	---	--





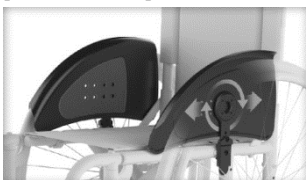

## Accoudoirs et manchettes d'accoudoirs

<p>Accoudoir en T réglable en hauteur (29cm-11,5" / 38cm -15") [5VARM039] [5VARM040]</p> 	<p>Accoudoir en T réglable en hauteur (21,6cm – 8,5" / 34cm - 13.5") [5VARM003] [5VARM004]</p> 	<p>Accoudoir en T plat réglable en hauteur (16,5cm-6.5"/26,7cm-10.5") [5VARM022] [5VARM023]</p> 	<p>Accoudoir en T réglable en hauteur, relevable (29,2cm – 11,5" / 38,1cm - 15") [50ARM041] [50ARM042]</p> 
<p>Accoudoir en T réglable en hauteur, relevable (24,1cm – 9,5" / 34,3cm - 13.5") [5VARM029] [5VARM030]</p> 	<p>Relevable, hauteur fixe (26,7cm – 10,5") [5VARM009] [5VARM008]</p> 	<p>Tube escamotable (26,7cm – 10,5" / 31,8cm – 12,5") [5VARM002]</p> 	<p>Manchette d'accoudoir enveloppante [5VARM020]</p> 

## Protections latérales

<p>Protège vêtement en composite [5VSDG002]</p> 	<p>Garde boue aluminium [5VSDG024] [5VSDG025]</p> 	<p>Garde boue aluminium réglable avec rembourrage en mousse [5VSDG014] [5VSDG015]</p> 	<p>Garde boue carbone réglable [5VSDG013]</p> 
---	---	--	---





## Roulettes anti-bascule, ceinture pelvienne et porte-oxygène

<p>Roulette anti-bascule, paire [5VATP001]</p> 	<p>Roulette anti-bascule pivotante [5VATP007] [5VATP008] [5VATP009]</p> 	<p>3.8 cm, fermeture à boucle [5VPOB001]</p> 
<p>3.8 m, fermeture à boucle rembourrée [5VPOB002]</p> 	<p>5 cm, boucle type avion [5VPOB003]</p> 	<p>Porte-oxygène [5VACC032] [5VACC033]</p> 

## Autres accessoires

<p>Kit d'outils [5VACC005]</p> 	<p>Pochette amovible sous le siège [5VACC015]</p> 	<p>Sac à dos KI Mobility pour enfant [5VACC026]</p> 
--	---	---



<p>Sac à dos KI Mobility [5VACC009]</p> 	<p>Porte mallette [5VACC025]</p> 	<p>Protection châssis avant en néoprène, noir [50IMG001]</p> 
<p>Porte canne [5VACC007]</p> 	<p>Support pour perfusions [5VACC022]</p> 	<p>Tube d'aide au basculement [5VACC036]</p> 