

Professionnel : _____

Client : _____

Contact : _____ Date : _____

Adresse : _____

 Devis Bon de Commande

Ville : _____ Code postal _____

Adresse : _____

Téléphone : _____

Remarques : _____

Mail : _____

Code LPPR: 6231841 (838,47 €)

 Libellé ordonnance : siège de série
modulaire évolutif

SÉLECTION DE L'ASSISE MODULAIRE ÉVOLUTIVE

 Dossier Axiom AP :

- Coussin d'assise Axiom G _____ 838,47 €
- Coussin d'assise Axiom S _____ 838,47 €
- Coussin d'assise Axiom P _____ 838,47 €
- Coussin d'assise Axiom SP Visco _____ 838,47 €
- Coussin d'assise Axiom SP Fluide _____ 868,47 €

 Dossier Axiom AGM :

- Coussin d'assise Axiom G _____ 838,47 €
- Coussin d'assise Axiom S _____ 838,47 €
- Coussin d'assise Axiom P _____ 838,47 €
- Coussin d'assise Axiom SP Visco _____ 858,47 €
- Coussin d'assise Axiom SP Fluide _____ 888,47 €

 Dossier Axiom AGP :

- Coussin d'assise Axiom G _____ 838,47 €
- Coussin d'assise Axiom S _____ 838,47 €
- Coussin d'assise Axiom P _____ 848,47 €
- Coussin d'assise Axiom SP Visco _____ 868,47 €
- Coussin d'assise Axiom SP Fluide _____ 898,47 €

Choix de la fixation du dossier

 Ajustable et amovible,
poids maximal
de 136 kg.

 DEX _____ 0 €

 Ajustable et amovible,
poids maximal
de 181 kg.

 BTX _____ 0 €

 Fixe et non amovible,
poids maximal
de 136 kg.

 FXT _____ 0 €

Coloris des coques de dossiers

Finition brillante

- | | |
|---|---|
| <input type="checkbox"/> Violet opalescent [AXMOVI] _____ 0 € | <input type="checkbox"/> Noir [AXMBLK] _____ 0 € |
| <input type="checkbox"/> Orange éclatant [AXMROR] _____ 0 € | <input type="checkbox"/> Bleu bonbon [AXMCBL] _____ 0 € |
| <input type="checkbox"/> Vert électrique [AXMEGN] _____ 0 € | <input type="checkbox"/> Violet bonbon [AXMPUR] _____ 0 € |
| <input type="checkbox"/> Bleu glacier [AXMGBL] _____ 0 € | <input type="checkbox"/> Rouge bonbon [AXMRED] _____ 0 € |
| <input type="checkbox"/> Rose foncé [AXMDPK] _____ 0 € | <input type="checkbox"/> Vert pomme [AXMGSM] _____ 0 € |
| <input type="checkbox"/> Rose clair [AXMLPK] _____ 0 € | <input type="checkbox"/> Orange métallique [AXMMOR] _____ 0 € |
| <input type="checkbox"/> Bleu sarcelle [AXMRTE] _____ 0 € | <input type="checkbox"/> Jaune [AXMYLW] _____ 0 € |
| <input type="checkbox"/> Violet aubergine [AXMPLM] _____ 0 € | |

Finition matte

- | | |
|---|---|
| <input type="checkbox"/> Rouge vif [AXMBRR] _____ 0 € | <input type="checkbox"/> Gris anthracite [AXMCGM] _____ 0 € |
| <input type="checkbox"/> Blanc [AXMWHT] _____ 0 € | <input type="checkbox"/> Bourgogne irisé [AXMIBM] _____ 0 € |
| <input type="checkbox"/> Sable [AXMTAN] _____ 0 € | <input type="checkbox"/> Bleu marine [AXMINM] _____ 0 € |
| <input type="checkbox"/> Vert kaki [AXMTGR] _____ 0 € | <input type="checkbox"/> Bleu royal [AXMRBM] _____ 0 € |

Finition métallique

- Bleu acier [AXMBLS] _____ 0 €

Choix du dossier AP

Dossier Axiom AP

Les dossiers bas ne sont pas compatibles avec des appui-têtes, des modifications ou des cale-troncs. Poids maximal : 136 kg.

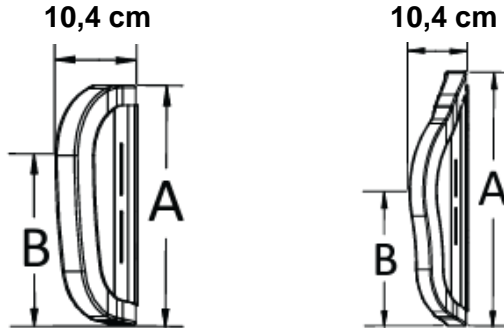

Dossier Axiom AP - Bas

Dossier Axiom AP - Moyen

		Référence pour la mesure du dossier postérieur Axiom			Profondeur du contour de la coque
		Hauteur du dossier	A	B	
Hauteur	Bas	20,3 cm	25,4 cm	16,5 cm	5,7 cm
		25,4 cm	30,5 cm	21,6 cm	
		30,5 cm	35,6 cm	26,7 cm	
	Moyen	35,6 cm	40,6 cm	21,6 cm	
		40,6 cm	45,7 cm	24,1 cm	
		45,7 cm	50,8 cm	26,7 cm	

		Largeur						
		0 €	0 €	0 €	0 €	0 €	120 €	
		12" (30,5cm)	14" (35,5cm)	16" (40,5cm)	18" (45,5cm)	20" (51cm)	22" (55,5cm)	
Hauteur	Bas	8" (20,5cm)	<input type="checkbox"/> AXPB1208	<input type="checkbox"/> AXPB1408	<input type="checkbox"/> AXPB1608	<input type="checkbox"/> AXPB1808	<input type="checkbox"/> AXPB2008	
		10" (25,5cm)		<input type="checkbox"/> AXPB1410	<input type="checkbox"/> AXPB1610	<input type="checkbox"/> AXPB1810	<input type="checkbox"/> AXPB2010	<input type="checkbox"/> AXPB2210
		12" (30,5cm)	<input type="checkbox"/> AXPB1212	<input type="checkbox"/> AXPB1412	<input type="checkbox"/> AXPB1612	<input type="checkbox"/> AXPB1812	<input type="checkbox"/> AXPB2012	
	Moyen	14" (35,5cm)		<input type="checkbox"/> AXPB1414	<input type="checkbox"/> AXPB1614	<input type="checkbox"/> AXPB1814	<input type="checkbox"/> AXPB2014	<input type="checkbox"/> AXPB2214
		16" (40,5cm)	<input type="checkbox"/> AXPB1216	<input type="checkbox"/> AXPB1416	<input type="checkbox"/> AXPB1616	<input type="checkbox"/> AXPB1816	<input type="checkbox"/> AXPB2016	
		18" (45,5cm)		<input type="checkbox"/> AXPB1418	<input type="checkbox"/> AXPB1618	<input type="checkbox"/> AXPB1818	<input type="checkbox"/> AXPB2018	<input type="checkbox"/> AXPB2218

Accessoires

Le matériel FXT n'est pas compatible avec les cale-troncs.

	Cale-troncs	Code produit	Prix
<input type="checkbox"/>	Cale-tronc 3 x 4, fixe (la paire)	PBLF3x4PP	310 €
<input type="checkbox"/>	Cale-tronc 4 x 5, fixe (la paire)	PBLF4X5PP	310 €
<input type="checkbox"/>	Cale-tronc 3 x 4, escamotable (la paire)	PBLS3X4PP	350 €
<input type="checkbox"/>	Cale-tronc 4 x 5, escamotable (la paire)	PBLS4X5PP	350 €
<input type="checkbox"/>	Cale-tronc 3 x 4, escamotable et réglable en angle (la paire)	PBLAS3X4PP	430 €
<input type="checkbox"/>	Cale-tronc 4 x 5, escamotable et réglable en angle (la paire)	PBLAS4X5PP	430 €

Options

- Support de fixation des ceintures [AXBSG] _____ 64,00 €
Comprend la modification du montage thoracique antérieur. Non compatible avec les dossiers bas.
- Coussin lombaire [LUMPAD] _____ 51,00 €
Uniquement disponible avec le dossier Axiom AGM et le dossier Axiom AGP.
- Rallonge de tissu couvrant le bas du dos (PRFLAP) _____ 39,00 €

Choix du dossier AGM

Dossier Axiom AGM

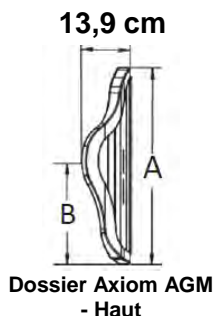
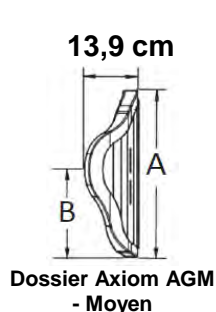
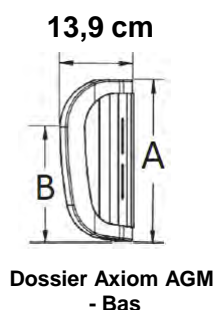

		Référence pour la mesure du dossier postérieur latéral Axiom			Profondeur du contour de la coque
		Hauteur du dossier	A	B	
Hauteur	Bas	20,3 cm	25,4 cm	16,5 cm	9,3 cm
		25,4 cm	30,5 cm	21,6 cm	
		30,5 cm	35,6 cm	26,7 cm	
	Moyen	35,6 cm	40,6 cm	21,6 cm	
		40,6 cm	45,7 cm	24,1 cm	
		45,7 cm	50,8 cm	26,7 cm	
		50,8 cm	55 cm	29,2 cm	
Haut	55,9 cm	60,9 cm	31,8 cm		

		Largeur						
		0 €	0 €	0 €	0 €	0 €	120 €	
		12" (30,5cm)	14" (35,5cm)	16" (40,5cm)	18" (45,5cm)	20" (51cm)	22" (55,5cm)	
Hauteur	Bas	8" (20,5cm)	<input type="checkbox"/> AXPL1208	<input type="checkbox"/> AXPL1408	<input type="checkbox"/> AXPL1608	<input type="checkbox"/> AXPL1808	<input type="checkbox"/> AXPL2008	
		10" (25,5cm)		<input type="checkbox"/> AXPL1410	<input type="checkbox"/> AXPL1610	<input type="checkbox"/> AXPL1810	<input type="checkbox"/> AXPL2010	<input type="checkbox"/> AXPL2210
		12" (30,5cm)	<input type="checkbox"/> AXPL1212	<input type="checkbox"/> AXPL1412	<input type="checkbox"/> AXPL1612	<input type="checkbox"/> AXPL1812	<input type="checkbox"/> AXPL2012	
	Moyen	14" (35,5cm)		<input type="checkbox"/> AXPL1414	<input type="checkbox"/> AXPL1614	<input type="checkbox"/> AXPL1814	<input type="checkbox"/> AXPL2014	<input type="checkbox"/> AXPL2214
		16" (40,5cm)	<input type="checkbox"/> AXPL1216	<input type="checkbox"/> AXPL1416	<input type="checkbox"/> AXPL1616	<input type="checkbox"/> AXPL1816	<input type="checkbox"/> AXPL2016	
		18" (45,5cm)		<input type="checkbox"/> AXPL1418	<input type="checkbox"/> AXPL1618	<input type="checkbox"/> AXPL1818	<input type="checkbox"/> AXPL2018	<input type="checkbox"/> AXPL2218
	Haut	20" (51cm)	<input type="checkbox"/> AXPL1220	<input type="checkbox"/> AXPL1420	<input type="checkbox"/> AXPL1620	<input type="checkbox"/> AXPL1820	<input type="checkbox"/> AXPL2020	
22" (55,5cm)			<input type="checkbox"/> AXPL1422	<input type="checkbox"/> AXPL1622	<input type="checkbox"/> AXPL1822	<input type="checkbox"/> AXPL2022	<input type="checkbox"/> AXPL2222	

Accessoires

Le matériel FXT n'est pas compatible avec les cale-troncs.

	Cale-troncs	Code produit	Prix
<input type="checkbox"/>	Cale-tronc 3 x 4, fixe (la paire)	PLLF3x4PP	310 €
<input type="checkbox"/>	Cale-tronc 4 x 5, fixe (la paire)	PLLF4x5PP	310 €
<input type="checkbox"/>	Cale-tronc 3 x 4, escamotable (la paire)	PLLS3x4PP	350 €
<input type="checkbox"/>	Cale-tronc 4 x 5, escamotable (la paire)	PLLS4x5PP	350 €
<input type="checkbox"/>	Cale-tronc 3 x 4, escamotable et réglable en angle (la paire)	PLLAS3x4PP	430 €
<input type="checkbox"/>	Cale-tronc 4 x 5, escamotable et réglable en angle (la paire)	PLLAS4x5PP	430 €

Options

- Support de fixation pour ceintures [AXBSG] _____ 64,00 €
Comprend la modification du montage thoracique antérieur. Non compatible avec les dossiers bas.
- Coussin lombaire [LUMPAD] _____ 51,00 €
Uniquement disponible avec le dossier Axiom AGM et le dossier Axiom AGP.
- Rallonge de tissu couvrant le bas du dos (PRFLAP) _____ 39,00 €

Choix du dossier AGP

Dossier Axiom AGP

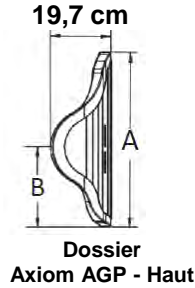
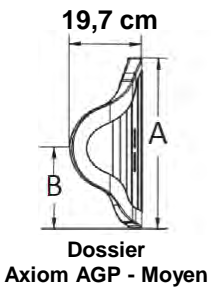

		Référence pour la mesure du dossier latéral profond Axiom							Profondeur du contour de la coque
		Hauteur du dossier	A	B ¹					
				30,5 cm	35,6 cm	40,6 cm	45,7 cm	50,8 cm	
Hauteur	Moyen	35,6 cm	40,6 cm	20,9 cm	20,9 cm	20,9 cm	20,9 cm	20,9 cm	15,2 cm
		40,6 cm	45,7 cm	23,5 cm	23,5 cm	23,5 cm	23,5 cm	23,5 cm	
		45,7 cm	50,8 cm	26,1 cm	26,1 cm	26,1 cm	26,1 cm	26,1 cm	
	Haut	50,8 cm	55,9 cm	24,1 cm	24,1 cm	24,8 cm	25,4 cm	26,1 cm	
		55,9 cm	58,4 cm	27,3 cm	27,3 cm	27,9 cm	29,2 cm	29,8 cm	

1. Les mesures sont basées sur la largeur du dossier.

		Largeur						
		0 €	0 €	0 €	0 €	0 €	120 €	
		12" (30,5cm)	14" (35,5cm)	16" (40,5cm)	18" (45,5cm)	20" (51cm)	22" (55,5cm)	
Hauteur	Moyen	14" (35,5cm)	<input type="checkbox"/> AXDL1214	<input type="checkbox"/> AXDL1414	<input type="checkbox"/> AXDL1614	<input type="checkbox"/> AXDL1814	<input type="checkbox"/> AXDL2014	<input type="checkbox"/> AXDL2214
		16" (40,5cm)		<input type="checkbox"/> AXDL1416	<input type="checkbox"/> AXDL1616	<input type="checkbox"/> AXDL1816	<input type="checkbox"/> AXDL2016	
		18" (45,5cm)	<input type="checkbox"/> AXDL1218	<input type="checkbox"/> AXDL1418	<input type="checkbox"/> AXDL1618	<input type="checkbox"/> AXDL1818	<input type="checkbox"/> AXDL2018	<input type="checkbox"/> AXDL2218
	Haut	20" (51cm)	<input type="checkbox"/> AXDL1220	<input type="checkbox"/> AXDL1420	<input type="checkbox"/> AXDL1620	<input type="checkbox"/> AXDL1820	<input type="checkbox"/> AXDL2020	
		22" (55,5cm)		<input type="checkbox"/> AXDL1422	<input type="checkbox"/> AXDL1622	<input type="checkbox"/> AXDL1822	<input type="checkbox"/> AXDL2022	<input type="checkbox"/> AXDL2222

Options

- Support de fixation des ceintures [AXBBSG] _____ 64,00 €
Comprend la modification du montage thoracique antérieur. Non compatible avec les dossiers bas.
- Coussin lombaire [LUMPAD] _____ 51,00 €
Uniquement disponible avec le dossier Axiom AGM et le dossier Axiom AGP.
- Rallonge de tissu couvrant le bas du dos (PRFLAP) _____ 39,00 €

Accessoires dossiers Axiom

Appuis-tête et matériel de montage

Description	Matériel de montage droit, réglable et escamotable		Matériel de montage multi-axes, réglable et escamotable		Matériel de montage Posalinc, réglable et escamotable		Matériel de montage Posalinc, réglable et relevable	
	Code produit	Prix	Code produit	Prix	Code produit	Prix	Code produit	Prix
Appui-tête Confort Soft 8" (20,3 cm)	<input type="checkbox"/> CS08SS	218 €	<input type="checkbox"/> CS08MA	238 €	<input type="checkbox"/> CS08PL	335 €	<input type="checkbox"/> CS08PLF	372 €
Appui-tête Confort Soft 10" (25,4 cm)	<input type="checkbox"/> CS10SS	218 €	<input type="checkbox"/> CS10MA	238 €	<input type="checkbox"/> CS10PL	335 €	<input type="checkbox"/> CS10PLF	372 €
Appui-tête Confort Soft 14" (35,6 cm)	<input type="checkbox"/> CS14SS	218 €	<input type="checkbox"/> CS14MA	238 €	<input type="checkbox"/> CS14PL	335 €	<input type="checkbox"/> CS14PLF	372 €
Appui-tête de positionnement - 8" x 6,25" / 20,3 x 15,8 cm	<input type="checkbox"/> CP08SS	218 €	<input type="checkbox"/> CP08MA	238 €	<input type="checkbox"/> CP08PL	335 €	<input type="checkbox"/> CP08PLF	372 €
Appui-tête de positionnement - 9" x 6,5" / 23 x 16,5 cm	<input type="checkbox"/> CP09SS	218 €	<input type="checkbox"/> CP09MA	238 €	<input type="checkbox"/> CP09PL	335 €	<input type="checkbox"/> CP09PLF	372 €
Appui-tête de positionnement - 10" x 7,5" / 25,4 x 19 cm	<input type="checkbox"/> CP10SS	218 €	<input type="checkbox"/> CP10MA	238 €	<input type="checkbox"/> CP10PL	335 €	<input type="checkbox"/> CP10PLF	372 €
Appui-tête Tri-Soft 10" (25,4 cm)	<input type="checkbox"/> TS10SS	218 €	<input type="checkbox"/> TS10MA	238 €	<input type="checkbox"/> TS10PL	335 €	<input type="checkbox"/> TS10PLF	372 €
Appui-tête Tri-Soft 14" (35,6 cm)	<input type="checkbox"/> TS14SS	218 €	<input type="checkbox"/> TS14MA	238 €	<input type="checkbox"/> TS14PL	335 €	<input type="checkbox"/> TS14PLF	372 €

Plaque de montage

Sélection non requise pour les appuis-tête Axiom.

Plaque de montage universelle pour appui-tête [UMP] _____ 34,00 €

Soutiens posturaux

La sélection d'une modification dans la rubrique "modifications du dossier Axiom" est requise pour monter le support de fixation de la ceinture. Non compatible avec les dossiers bas.

	Description	Code produit	Prix
<input type="checkbox"/>	Ceinture thoracique Dynaform : scratch, coussin de 3" (7,6 cm) de hauteur, petit	14941	78 €
<input type="checkbox"/>	Ceinture thoracique Dynaform : scratch, coussin de 4" (10,2 cm) de hauteur, moyen	14942	78 €
<input type="checkbox"/>	Ceinture thoracique Dynaform : scratch, coussin de 5" (12,7 cm) de hauteur, large	14943	78 €
<input type="checkbox"/>	Ceinture thoracique Dynaform : boucle plastique, hauteur 3" (7,6 cm), largeur 20" (51 cm), petit	14924	71 €
<input type="checkbox"/>	Ceinture thoracique Dynaform : boucle plastique, hauteur 4" (10,2 cm), largeur 20" (51 cm), moyen	14927	71 €
<input type="checkbox"/>	Ceinture thoracique Dynaform : boucle plastique, hauteur 4" (10,2 cm), largeur 22" (56 cm), large	14928	71 €
<input type="checkbox"/>	Harnais 4 points Dynaform : standard, dynamique, très petit	14851	78 €
<input type="checkbox"/>	Harnais 4 points Dynaform : standard, dynamique, petit	14852	78 €
<input type="checkbox"/>	Harnais 4 points Dynaform : standard, dynamique, moyen	14853	78 €
<input type="checkbox"/>	Harnais 4 points Dynaform : standard, dynamique, large	14854	78 €
<input type="checkbox"/>	Harnais 4 points Dynaform : ajusté, dynamique, très petit	14856	78 €
<input type="checkbox"/>	Harnais 4 points Dynaform : ajusté, dynamique, petit	14857	78 €
<input type="checkbox"/>	Harnais 4 points Dynaform : ajusté, dynamique, moyen	14858	78 €
<input type="checkbox"/>	Harnais 4 points Dynaform : ajusté, dynamique, large	14859	78 €
<input type="checkbox"/>	Harnais 4 points AirLogic : standard, petit	14282	115 €
<input type="checkbox"/>	Harnais 4 points AirLogic : standard, moyen	14283	115 €
<input type="checkbox"/>	Harnais 4 points AirLogic : standard, large	14284	115 €
<input type="checkbox"/>	Harnais 4 points AirLogic : standard, très large	14285	115 €
<input type="checkbox"/>	Harnais 4 points AirLogic : ajusté, dynamique, petit	14257	115 €
<input type="checkbox"/>	Harnais 4 points AirLogic : ajusté, dynamique, moyen	14258	115 €
<input type="checkbox"/>	Harnais 4 points AirLogic : ajusté, dynamique, large	14259	115 €
<input type="checkbox"/>	Harnais 4 points AirLogic : ajusté, dynamique, très large	14260	115 €

Choix du coussin d'assise

Axiom G - livré avec deux housses

Capacité de poids : 158 kg.

		Largeur							
		35.5 cm - 14"	38 cm - 15"	40.5 cm - 16"	43 cm - 17"	45.5 cm - 18"	48 cm - 19"	51 cm - 20"	56 cm - 22"
		0 €	0 €	0 €	0 €	0 €	0 €	0 €	20 €
Profondeur	35.5 cm - 14"	<input type="checkbox"/> XG1414C2							
	38 cm - 15"	<input type="checkbox"/> XG1415C2	<input type="checkbox"/> XG1515C2	<input type="checkbox"/> XG1615C2					
	40.5 cm - 16"	<input type="checkbox"/> XG1416C	<input type="checkbox"/> XG1516C2	<input type="checkbox"/> XG1616C2	<input type="checkbox"/> XG1716C2	<input type="checkbox"/> XG1816C2	<input type="checkbox"/> XG1916C2	<input type="checkbox"/> XG2016C2	
	43 cm - 17"	<input type="checkbox"/> XG1417C2	<input type="checkbox"/> XG1517C2	<input type="checkbox"/> XG1617C2	<input type="checkbox"/> XG1717C2	<input type="checkbox"/> XG1817C2	<input type="checkbox"/> XG1917C2	<input type="checkbox"/> XG2017C2	
	45.5 cm - 18"	<input type="checkbox"/> XG1418C2	<input type="checkbox"/> XG1518C2	<input type="checkbox"/> XG1618C2	<input type="checkbox"/> XG1718C2	<input type="checkbox"/> XG1818C2	<input type="checkbox"/> XG1918C2	<input type="checkbox"/> XG2018C2	<input type="checkbox"/> XG2218C2
	48 cm - 19"		<input type="checkbox"/> XG1519C2	<input type="checkbox"/> XG1619C2	<input type="checkbox"/> XG1719C2	<input type="checkbox"/> XG1819C2	<input type="checkbox"/> XG1919C2	<input type="checkbox"/> XG2019C2	<input type="checkbox"/> XG2219C2
	51 cm - 20"		<input type="checkbox"/> XG1520C2	<input type="checkbox"/> XG1620C2	<input type="checkbox"/> XG1720C2	<input type="checkbox"/> XG1820C2	<input type="checkbox"/> XG1920C2	<input type="checkbox"/> XG2020C2	<input type="checkbox"/> XG2220C2
	53 cm - 21"			<input type="checkbox"/> XG1621C2		<input type="checkbox"/> XG1821C2	<input type="checkbox"/> XG1921C2	<input type="checkbox"/> XG2021C2	<input type="checkbox"/> XG2221C2
	56 cm - 22"			<input type="checkbox"/> XG1622C2		<input type="checkbox"/> XG1822C2	<input type="checkbox"/> XG1922C2	<input type="checkbox"/> XG2022C2	<input type="checkbox"/> XG2222C2

Axiom S - livré avec une seule housse

Capacité de poids : 158 kg.

		Largeur							
		35.5 cm - 14"	38 cm - 15"	40.5 cm - 16"	43 cm - 17"	45.5 cm - 18"	48 cm - 19"	51 cm - 20"	56 cm - 22"
		0 €	0 €	0 €	0 €	0 €	0 €	0 €	40 €
Profondeur	35.5 cm - 14"	<input type="checkbox"/> XS1414							
	38 cm - 15"	<input type="checkbox"/> XS1415	<input type="checkbox"/> XS1515	<input type="checkbox"/> XS1615					
	40.5 cm - 16"	<input type="checkbox"/> XS1416	<input type="checkbox"/> XS1516	<input type="checkbox"/> XS1616	<input type="checkbox"/> XS1716	<input type="checkbox"/> XS1816	<input type="checkbox"/> XS1916	<input type="checkbox"/> XS2016	
	43 cm - 17"	<input type="checkbox"/> XS1417	<input type="checkbox"/> XS1517	<input type="checkbox"/> XS1617	<input type="checkbox"/> XS1717	<input type="checkbox"/> XS1817	<input type="checkbox"/> XS1917	<input type="checkbox"/> XS2017	
	45.5 cm - 18"	<input type="checkbox"/> XS1418	<input type="checkbox"/> XS1518	<input type="checkbox"/> XS1618	<input type="checkbox"/> XS1718	<input type="checkbox"/> XS1818	<input type="checkbox"/> XS1918	<input type="checkbox"/> XS2018	<input type="checkbox"/> XS2218
	48 cm - 19"		<input type="checkbox"/> XS1519	<input type="checkbox"/> XS1619	<input type="checkbox"/> XS1719	<input type="checkbox"/> XS1819	<input type="checkbox"/> XS1919	<input type="checkbox"/> XS2019	<input type="checkbox"/> XS2219
	51 cm - 20"		<input type="checkbox"/> XS1520	<input type="checkbox"/> XS1620	<input type="checkbox"/> XS1720	<input type="checkbox"/> XS1820	<input type="checkbox"/> XS1920	<input type="checkbox"/> XS2020	<input type="checkbox"/> XS2220
	53 cm - 21"			<input type="checkbox"/> XS1621		<input type="checkbox"/> XS1821	<input type="checkbox"/> XS1921	<input type="checkbox"/> XS2021	<input type="checkbox"/> XS2221
	56 cm - 22"			<input type="checkbox"/> XS1622		<input type="checkbox"/> XS1822	<input type="checkbox"/> XS1922	<input type="checkbox"/> XS2022	<input type="checkbox"/> XS2222

Axiom S - livré avec deux housses

Capacité de poids : 158 kg.

		Largeur							
		35.5 cm - 14"	38 cm - 15"	40.5 cm - 16"	43 cm - 17"	45.5 cm - 18"	48 cm - 19"	51 cm - 20"	56 cm - 22"
		65 €	65 €	65 €	65 €	65 €	65 €	65 €	105 €
Profondeur	35.5 cm - 14"	<input type="checkbox"/> XS1414C2							
	38 cm - 15"	<input type="checkbox"/> XS1415C2	<input type="checkbox"/> XS1515C2	<input type="checkbox"/> XS1615C2					
	40.5 cm - 16"	<input type="checkbox"/> XS1416C2	<input type="checkbox"/> XS1516C2	<input type="checkbox"/> XS1616C2	<input type="checkbox"/> XS1716C2	<input type="checkbox"/> XS1816C2	<input type="checkbox"/> XS1916C2	<input type="checkbox"/> XS2016C2	
	43 cm - 17"	<input type="checkbox"/> XS1417C2	<input type="checkbox"/> XS1517C2	<input type="checkbox"/> XS1617C2	<input type="checkbox"/> XS1717C2	<input type="checkbox"/> XS1817C2	<input type="checkbox"/> XS1917C2	<input type="checkbox"/> XS2017C2	
	45.5 cm - 18"	<input type="checkbox"/> XS1418C2	<input type="checkbox"/> XS1518C2	<input type="checkbox"/> XS1618C2	<input type="checkbox"/> XS1718C2	<input type="checkbox"/> XS1818C2	<input type="checkbox"/> XS1918C2	<input type="checkbox"/> XS2018C2	<input type="checkbox"/> XS2218C2
	48 cm - 19"		<input type="checkbox"/> XS1519C2	<input type="checkbox"/> XS1619C2	<input type="checkbox"/> XSC719C2	<input type="checkbox"/> XS1819C2	<input type="checkbox"/> XS1919C2	<input type="checkbox"/> XS2019C2	<input type="checkbox"/> XS2219C2
	51 cm - 20"		<input type="checkbox"/> XS1520C2	<input type="checkbox"/> XS1620C2	<input type="checkbox"/> XS1720C2	<input type="checkbox"/> XS1820C2	<input type="checkbox"/> XS1920C2	<input type="checkbox"/> XS2020C2	<input type="checkbox"/> XS2220C2
	53 cm - 21"			<input type="checkbox"/> XS1621C2		<input type="checkbox"/> XS1821C2	<input type="checkbox"/> XS1921C2	<input type="checkbox"/> XS2021C2	<input type="checkbox"/> XS2221C2
	56 cm - 22"			<input type="checkbox"/> XS1622C2		<input type="checkbox"/> XS1822C2	<input type="checkbox"/> XS1922C2	<input type="checkbox"/> XS2022C2	<input type="checkbox"/> XS2222C2

Choix du coussin d'assise

Axiom P – livré avec une seule housse

Capacité de poids : 158 kg.

		Largeur							
		35.5 cm - 14"	38 cm - 15"	40.5 cm - 16"	43 cm - 17"	45.5 cm - 18"	48 cm - 19"	51 cm - 20"	56 cm - 22"
		0 €	0 €	0 €	0 €	0 €	0 €	0 €	50 €
Profondeur	35.5 cm - 14"	<input type="checkbox"/> XP1414							
	38 cm - 15"	<input type="checkbox"/> XP1415	<input type="checkbox"/> XP1515	<input type="checkbox"/> XP1615					
	40.5 cm - 16"	<input type="checkbox"/> XP1416	<input type="checkbox"/> XP1516	<input type="checkbox"/> XP1616	<input type="checkbox"/> XP1716	<input type="checkbox"/> XP1816	<input type="checkbox"/> XP1916	<input type="checkbox"/> XP2016	
	43 cm - 17"	<input type="checkbox"/> XP1417	<input type="checkbox"/> XP1517	<input type="checkbox"/> XP1617	<input type="checkbox"/> XP1717	<input type="checkbox"/> XP1817	<input type="checkbox"/> XP1917	<input type="checkbox"/> XP2017	
	45.5 cm - 18"	<input type="checkbox"/> XP1418	<input type="checkbox"/> XP1518	<input type="checkbox"/> XP1618	<input type="checkbox"/> XP1718	<input type="checkbox"/> XP1818	<input type="checkbox"/> XP1918	<input type="checkbox"/> XP2018	<input type="checkbox"/> XP2218
	48 cm - 19"		<input type="checkbox"/> XP1519	<input type="checkbox"/> XP1619	<input type="checkbox"/> XP1719	<input type="checkbox"/> XP1819	<input type="checkbox"/> XP1919	<input type="checkbox"/> XP2019	<input type="checkbox"/> XP2219
	51 cm - 20"		<input type="checkbox"/> XP1520	<input type="checkbox"/> XP1620	<input type="checkbox"/> XP1720	<input type="checkbox"/> XP1820	<input type="checkbox"/> XP1920	<input type="checkbox"/> XP2020	<input type="checkbox"/> XP2220
	53 cm - 21"			<input type="checkbox"/> XP1621		<input type="checkbox"/> XP1821	<input type="checkbox"/> XP1921	<input type="checkbox"/> XP2021	<input type="checkbox"/> XP2221
	56 cm - 22"			<input type="checkbox"/> XP1622		<input type="checkbox"/> XP1822	<input type="checkbox"/> XP1922	<input type="checkbox"/> XP2022	<input type="checkbox"/> XP2222

Axiom P – livré avec deux housses

		Largeur							
		35.5 cm - 14"	38 cm - 15"	40.5 cm - 16"	43 cm - 17"	45.5 cm - 18"	48 cm - 19"	51 cm - 20"	56 cm - 22"
		65 €	65 €	65 €	65 €	65 €	65 €	65 €	115 €
Profondeur	35.5 cm - 14"	<input type="checkbox"/> XP1414C2							
	38 cm - 15"	<input type="checkbox"/> XP1415C2	<input type="checkbox"/> XP1515C2	<input type="checkbox"/> XP1615C2					
	40.5 cm - 16"	<input type="checkbox"/> XP1416C2	<input type="checkbox"/> XP1516C2	<input type="checkbox"/> XP1616C2	<input type="checkbox"/> XP1716C2	<input type="checkbox"/> XP1816C2	<input type="checkbox"/> XP1916C2	<input type="checkbox"/> XP2016C2	
	43 cm - 17"	<input type="checkbox"/> XP1417C2	<input type="checkbox"/> XP1517C2	<input type="checkbox"/> XP1617C2	<input type="checkbox"/> XP1717C2	<input type="checkbox"/> XP1817C2	<input type="checkbox"/> XP1917C2	<input type="checkbox"/> XP2017C2	
	45.5 cm - 18"	<input type="checkbox"/> XP1418C2	<input type="checkbox"/> XP1518C2	<input type="checkbox"/> XP1618C2	<input type="checkbox"/> XP1718C2	<input type="checkbox"/> XP1818C2	<input type="checkbox"/> XP1918C2	<input type="checkbox"/> XP2018C2	<input type="checkbox"/> XP2218C2
	48 cm - 19"		<input type="checkbox"/> XP1519C2	<input type="checkbox"/> XP1619C2	<input type="checkbox"/> XP1719C2	<input type="checkbox"/> XP1819C2	<input type="checkbox"/> XP1919C2	<input type="checkbox"/> XP2019C2	<input type="checkbox"/> XP2219C2
	51 cm - 20"		<input type="checkbox"/> XP1520C2	<input type="checkbox"/> XP1620C2	<input type="checkbox"/> XP1720C2	<input type="checkbox"/> XP1820C2	<input type="checkbox"/> XP1920C2	<input type="checkbox"/> XP2020C2	<input type="checkbox"/> XP2220C2
	53 cm - 21"			<input type="checkbox"/> XP1621C2		<input type="checkbox"/> XP1821C2	<input type="checkbox"/> XP1921C2	<input type="checkbox"/> XP2021C2	<input type="checkbox"/> XP2221C2
	56 cm - 22"			<input type="checkbox"/> XP1622C2		<input type="checkbox"/> XP1822C2	<input type="checkbox"/> XP1922C2	<input type="checkbox"/> XP2022C2	<input type="checkbox"/> XP2222C2

Choix du coussin d'assise

Axiom SP Visco – livré avec une seule housse

Capacité de poids : 158 kg.

		Largeur en cm								
		35.5 cm - 14"	38 cm - 15"	40.5 cm - 16"	43 cm - 17"	45.5 cm - 18"	48 cm - 19"	51 cm - 20"	53 cm - 21"	56 cm - 22"
		0 €	0 €	0 €	0 €	0 €	0 €	0 €	55 €	55 €
Profondeur	35.5 cm - 14"	<input type="checkbox"/> XSP1414V	<input type="checkbox"/> XSP1514V	<input type="checkbox"/> XSP1614V						
	38 cm - 15"	<input type="checkbox"/> XSP1415V	<input type="checkbox"/> XSP1515V	<input type="checkbox"/> XSP1615V	<input type="checkbox"/> XSP1715V	<input type="checkbox"/> XSP1815V				
	40.5 cm - 16"	<input type="checkbox"/> XSP1416V	<input type="checkbox"/> XSP1516V	<input type="checkbox"/> XSP1616V	<input type="checkbox"/> XSP1716V	<input type="checkbox"/> XSP1816V	<input type="checkbox"/> XSP1916V	<input type="checkbox"/> XSP2016V		<input type="checkbox"/> XSP2216V
	43 cm - 17"	<input type="checkbox"/> XSP1417V	<input type="checkbox"/> XSP1517V	<input type="checkbox"/> XSP1617V	<input type="checkbox"/> XSP1717V	<input type="checkbox"/> XSP1817V	<input type="checkbox"/> XSP1917V	<input type="checkbox"/> XSP2017V		<input type="checkbox"/> XSP2217V
	45.5 cm - 18"	<input type="checkbox"/> XSP1418V	<input type="checkbox"/> XSP1518V	<input type="checkbox"/> XSP1618V	<input type="checkbox"/> XSP1718V	<input type="checkbox"/> XSP1818V	<input type="checkbox"/> XSP1918V	<input type="checkbox"/> XSP2018V	<input type="checkbox"/> XSP2118V	<input type="checkbox"/> XSP2218V
	48 cm - 19"	<input type="checkbox"/> XSP1419V	<input type="checkbox"/> XSP1519V	<input type="checkbox"/> XSP1619V	<input type="checkbox"/> XSP1719V	<input type="checkbox"/> XSP1819V	<input type="checkbox"/> XSP1919V	<input type="checkbox"/> XSP2019V	<input type="checkbox"/> XSP2119V	<input type="checkbox"/> XSP2219V
	51 cm - 20"	<input type="checkbox"/> XSP1420V	<input type="checkbox"/> XSP1520V	<input type="checkbox"/> XSP1620V	<input type="checkbox"/> XSP1720V	<input type="checkbox"/> XSP1820V	<input type="checkbox"/> XSP1920V	<input type="checkbox"/> XSP2020V	<input type="checkbox"/> XSP2120V	<input type="checkbox"/> XSP2220V
	53 cm - 21"		<input type="checkbox"/> XSP1521V	<input type="checkbox"/> XSP1621V	<input type="checkbox"/> XSP1721V	<input type="checkbox"/> XSP1821V	<input type="checkbox"/> XSP1921V	<input type="checkbox"/> XSP2021V	<input type="checkbox"/> XSP2121V	<input type="checkbox"/> XSP2221V
	56 cm - 22"		<input type="checkbox"/> XSP1522V	<input type="checkbox"/> XSP1622V	<input type="checkbox"/> XSP1722V	<input type="checkbox"/> XSP1822V	<input type="checkbox"/> XSP1922V	<input type="checkbox"/> XSP2022V	<input type="checkbox"/> XSP2122V	<input type="checkbox"/> XSP2222V

Axiom SP Visco – livré avec deux housses

		Largeur en cm								
		35.5 cm - 14"	38 cm - 15"	40.5 cm - 16"	43 cm - 17"	45.5 cm - 18"	48 cm - 19"	51 cm - 20"	53 cm - 21"	56 cm - 22"
		65 €	65 €	65 €	65 €	65 €	65 €	65 €	120 €	120 €
Profondeur	35.5 cm - 14"	<input type="checkbox"/> XSP1414VC2	<input type="checkbox"/> XSP1514VC2	<input type="checkbox"/> XSP1614VC2						
	38 cm - 15"	<input type="checkbox"/> XSP1415VC2	<input type="checkbox"/> XSP1515VC2	<input type="checkbox"/> XSP1615VC2	<input type="checkbox"/> XSP1715VC2	<input type="checkbox"/> XSP1815VC2				
	40.5 cm - 16"	<input type="checkbox"/> XSP1416VC2	<input type="checkbox"/> XSP1516VC2	<input type="checkbox"/> XSP1616VC2	<input type="checkbox"/> XSP1716VC2	<input type="checkbox"/> XSP1816VC2	<input type="checkbox"/> XSP1916VC2	<input type="checkbox"/> XSP2016VC2		<input type="checkbox"/> XSP2216VC2
	43 cm - 17"	<input type="checkbox"/> XSP1417VC2	<input type="checkbox"/> XSP1517VC2	<input type="checkbox"/> XSP1617VC2	<input type="checkbox"/> XSP1717VC2	<input type="checkbox"/> XSP1817VC2	<input type="checkbox"/> XSP1917VC2	<input type="checkbox"/> XSP2017VC2		<input type="checkbox"/> XSP2217VC2
	45.5 cm - 18"	<input type="checkbox"/> XSP1418VC2	<input type="checkbox"/> XSP1518VC2	<input type="checkbox"/> XSP1618VC2	<input type="checkbox"/> XSP1718VC2	<input type="checkbox"/> XSP1818VC2	<input type="checkbox"/> XSP1918VC2	<input type="checkbox"/> XSP2018VC2	<input type="checkbox"/> XSP2118VC2	<input type="checkbox"/> XSP2218VC2
	48 cm - 19"	<input type="checkbox"/> XSP1419VC2	<input type="checkbox"/> XSP1519VC2	<input type="checkbox"/> XSP1619VC2	<input type="checkbox"/> XSP1719VC2	<input type="checkbox"/> XSP1819VC2	<input type="checkbox"/> XSP1919VC2	<input type="checkbox"/> XSP2019VC2	<input type="checkbox"/> XSP2119VC2	<input type="checkbox"/> XSP2219VC2
	51 cm - 20"	<input type="checkbox"/> XSP1420VC2	<input type="checkbox"/> XSP1520VC2	<input type="checkbox"/> XSP1620VC2	<input type="checkbox"/> XSP1720VC2	<input type="checkbox"/> XSP1820VC2	<input type="checkbox"/> XSP1920VC2	<input type="checkbox"/> XSP2020VC2	<input type="checkbox"/> XSP2120VC2	<input type="checkbox"/> XSP2220VC2
	53 cm - 21"		<input type="checkbox"/> XSP1521VC2	<input type="checkbox"/> XSP1621VC2	<input type="checkbox"/> XSP1721VC2	<input type="checkbox"/> XSP1821VC2	<input type="checkbox"/> XSP1921VC2	<input type="checkbox"/> XSP2021VC2	<input type="checkbox"/> XSP2121VC2	<input type="checkbox"/> XSP2221VC2
	56 cm - 22"		<input type="checkbox"/> XSP1522VC2	<input type="checkbox"/> XSP1622VC2	<input type="checkbox"/> XSP1722VC2	<input type="checkbox"/> XSP1822VC2	<input type="checkbox"/> XSP1922VC2	<input type="checkbox"/> XSP2022VC2	<input type="checkbox"/> XSP2122VC2	<input type="checkbox"/> XSP2222VC2

Choix du coussin d'assise

Axiom SP Fluide – livré avec une seule housse

Capacité de poids : 158 kg.

		Largeur en cm								
		35.5 cm - 14"	38 cm - 15"	40.5 cm - 16"	43 cm - 17"	45.5 cm - 18"	48 cm - 19"	51 cm - 20"	53 cm - 21"	56 cm - 22"
		0 €	0 €	0 €	0 €	0 €	0 €	0 €	65 €	65 €
Profondeur	35.5 cm - 14"	<input type="checkbox"/> XSP1414F	<input type="checkbox"/> XSP1514F	<input type="checkbox"/> XSP1615F						
	38 cm - 15"	<input type="checkbox"/> XSP1415F	<input type="checkbox"/> XSP1515F	<input type="checkbox"/> XSP1615F	<input type="checkbox"/> XSP1715F	<input type="checkbox"/> XSP1815F				
	40.5 cm - 16"	<input type="checkbox"/> XSP1416F	<input type="checkbox"/> XSP1516F	<input type="checkbox"/> XSP1616F	<input type="checkbox"/> XSP1716F	<input type="checkbox"/> XSP1816F	<input type="checkbox"/> XSP1916F	<input type="checkbox"/> XSP2016F		<input type="checkbox"/> XSP2216F
	43 cm - 17"	<input type="checkbox"/> XSP1417F	<input type="checkbox"/> XSP1517F	<input type="checkbox"/> XSP1617F	<input type="checkbox"/> XSP1717F	<input type="checkbox"/> XSP1817F	<input type="checkbox"/> XSP1917F	<input type="checkbox"/> XSP2017F		<input type="checkbox"/> XSP2217F
	45.5 cm - 18"	<input type="checkbox"/> XSP1418F	<input type="checkbox"/> XSP1518F	<input type="checkbox"/> XSP1618F	<input type="checkbox"/> XSP1718F	<input type="checkbox"/> XSP1818F	<input type="checkbox"/> XSP1918F	<input type="checkbox"/> XSP2018F	<input type="checkbox"/> XSP2118F	<input type="checkbox"/> XSP2218F
	48 cm - 19"	<input type="checkbox"/> XSP1419F	<input type="checkbox"/> XSP1519F	<input type="checkbox"/> XSP1619F	<input type="checkbox"/> XSP1719F	<input type="checkbox"/> XSP1819F	<input type="checkbox"/> XSP1919F	<input type="checkbox"/> XSP2019F	<input type="checkbox"/> XSP2119F	<input type="checkbox"/> XSP2219F
	51 cm - 20"	<input type="checkbox"/> XSP1420F	<input type="checkbox"/> XSP1520F	<input type="checkbox"/> XSP1620F	<input type="checkbox"/> XSP1720F	<input type="checkbox"/> XSP1820F	<input type="checkbox"/> XSP1920F	<input type="checkbox"/> XSP2020F	<input type="checkbox"/> XSP2120F	<input type="checkbox"/> XSP2220F
	53 cm - 21"		<input type="checkbox"/> XSP1521F	<input type="checkbox"/> XSP1621F	<input type="checkbox"/> XSP1721F	<input type="checkbox"/> XSP1821F	<input type="checkbox"/> XSP1921F	<input type="checkbox"/> XSP2021F	<input type="checkbox"/> XSP2121F	<input type="checkbox"/> XSP2221F
56 cm - 22"		<input type="checkbox"/> XSP1522F	<input type="checkbox"/> XSP1622F	<input type="checkbox"/> XSP1722F	<input type="checkbox"/> XSP1822F	<input type="checkbox"/> XSP1922F	<input type="checkbox"/> XSP2022F	<input type="checkbox"/> XSP2122F	<input type="checkbox"/> XSP2222F	











Axiom SP Fluide – livré avec deux housses

		Largeur en cm								
		35.5 cm - 14"	38 cm - 15"	40.5 cm - 16"	43 cm - 17"	45.5 cm - 18"	48 cm - 19"	51 cm - 20"	53 cm - 21"	56 cm - 22"
		65 €	65 €	65 €	65 €	65 €	65 €	65 €	130 €	130 €
Profondeur	35.5 cm - 14"	<input type="checkbox"/> XSP1414FC2	<input type="checkbox"/> XSP1514FC2	<input type="checkbox"/> XSP1614FC2						
	38 cm - 15"	<input type="checkbox"/> XSP1415FC2	<input type="checkbox"/> XSP1515FC2	<input type="checkbox"/> XSP1615FC2	<input type="checkbox"/> XSP1715FC2	<input type="checkbox"/> XSP1815FC2				
	40.5 cm - 16"	<input type="checkbox"/> XSP1416FC2	<input type="checkbox"/> XSP1516FC2	<input type="checkbox"/> XSP1616FC2	<input type="checkbox"/> XSP1716FC2	<input type="checkbox"/> XSP1816FC2	<input type="checkbox"/> XSP1916FC2	<input type="checkbox"/> XSP2016FC2		<input type="checkbox"/> XSP2216FC2
	43 cm - 17"	<input type="checkbox"/> XSP1417FC2	<input type="checkbox"/> XSP1517FC2	<input type="checkbox"/> XSP1617FC2	<input type="checkbox"/> XSP1717FC2	<input type="checkbox"/> XSP1817FC2	<input type="checkbox"/> XSP1917FC2	<input type="checkbox"/> XSP2017FC2		<input type="checkbox"/> XSP2217FC2
	45.5 cm - 18"	<input type="checkbox"/> XSP1418FC2	<input type="checkbox"/> XSP1518FC2	<input type="checkbox"/> XSP1618FC2	<input type="checkbox"/> XSP1718FC2	<input type="checkbox"/> XSP1818FC2	<input type="checkbox"/> XSP1918FC2	<input type="checkbox"/> XSP2018FC2	<input type="checkbox"/> XSP2118FC2	<input type="checkbox"/> XSP2218FC2
	48 cm - 19"	<input type="checkbox"/> XSP1419FC2	<input type="checkbox"/> XSP1519FC2	<input type="checkbox"/> XSP1619FC2	<input type="checkbox"/> XSP1719FC2	<input type="checkbox"/> XSP1819FC2	<input type="checkbox"/> XSP1919FC2	<input type="checkbox"/> XSP2019FC2	<input type="checkbox"/> XSP2119FC2	<input type="checkbox"/> XSP2219FC2
	51 cm - 20"	<input type="checkbox"/> XSP1420FC2	<input type="checkbox"/> XSP1520FC2	<input type="checkbox"/> XSP1620FC2	<input type="checkbox"/> XSP1720FC2	<input type="checkbox"/> XSP1820FC2	<input type="checkbox"/> XSP1920FC2	<input type="checkbox"/> XSP2020FC2	<input type="checkbox"/> XSP2120FC2	<input type="checkbox"/> XSP2220FC2
	53 cm - 21"		<input type="checkbox"/> XSP1521FC2	<input type="checkbox"/> XSP1621FC2	<input type="checkbox"/> XSP1721FC2	<input type="checkbox"/> XSP1821FC2	<input type="checkbox"/> XSP1921FC2	<input type="checkbox"/> XSP2021FC2	<input type="checkbox"/> XSP2121FC2	<input type="checkbox"/> XSP2221FC2
56 cm - 22"		<input type="checkbox"/> XSP1522FC2	<input type="checkbox"/> XSP1622FC2	<input type="checkbox"/> XSP1722FC2	<input type="checkbox"/> XSP1822FC2	<input type="checkbox"/> XSP1922FC2	<input type="checkbox"/> XSP2022FC2	<input type="checkbox"/> XSP2122FC2	<input type="checkbox"/> XSP2222FC2	

Portfolio

 <p>Dossier Axiom AP</p>	 <p>Dossier Axiom AGM</p>	 <p>Dossier AGP</p>
 <p>Cale-tronc fixe</p>	 <p>Cale-tronc escamotable</p>	 <p>Cale-tronc escamotable et réglable en angle</p>
 <p>Appui-tête Confort Soft</p>	 <p>Appui-tête de positionnement</p>	 <p>Appui-tête Tri-Soft</p>
 <p>laque de montage universelle pour appui-tête autre</p>	 <p>Matériel droit, réglable et escamotable</p>	 <p>Matériel à plusieurs axes, réglable et escamotable</p>

Portfolio (suite)

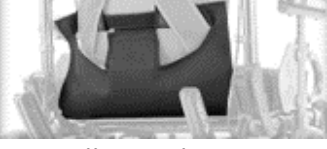
 <p>Matériel Posalinc, réglable et escamotable</p>	 <p>Matériel de montage Posalinc, réglable et relevable</p>	 <p>Ceinture thoracique Dynaform : scratch</p>
 <p>Ceinture thoracique Dynaform : boucle plastique</p>	 <p>Harnais 4 points Dynaform : standard, dynamique</p>	 <p>Harnais 4 points Dynaform : ajusté, dynamique</p>
 <p>Harnais 4 points AirLogic : standard</p>	 <p>Harnais 4 points AirLogic : ajusté, dynamique</p>	 <p>Support de fixation de la ceinture</p>
 <p>Coussin lombaire</p>	 <p>Rallonge de tissu couvrant le bas du dos</p>	